

CC880/LP880, SC8016



Security Systems

EN | Operators Guide
Solution-16,
Solution-16 Safecom

BOSCH

Copyright Notice

Unless otherwise indicated, this publication is the copyright of Bosch Security Systems Pty Ltd (“**Bosch**”). All rights are reserved.

You may download a single copy of this publication. By downloading the publication you agree that you will: (i) only use the publication for your own reference; (ii) not commercially exploit or charge any person for the use of the publication; and (iii) not modify the publication in any way without the prior written permission of Bosch.

Except as specified above or where authorised by the Copyright Act 1968 (Cth), no part of this publication may be reproduced, transmitted, modified or stored, in any form or by any means, without the prior written permission of Bosch.

Notice of Liability

This material is designed for use by tradespeople with expertise in the installation of this product. Persons without appropriate expertise should seek assistance before attempting installation.

While care was taken in the preparation of this material, Bosch Security Systems Pty Ltd and its representatives are not responsible to any person or entity for any loss or damage directly or indirectly caused by information in, or any omission from, this material.

Bosch Security Systems Pty Ltd reserves the right to make changes to features and specifications of its products at any time without prior notification.

New Zealand Telepermit Notes

The grant of a telepermit for a device in no way indicates Telecom acceptance of responsibility for the correct operation of that device under all operating conditions.

This equipment can not be used in any manner that could constitute a nuisance to other telecom customers.

Immediately disconnect this equipment should it become physically damaged and arrange for its disposal or repair.

The transmit level from this device is set at a fixed level and because of this, there may be circumstances where the performance is less than optimal. Before reporting such occurrences as faults, please check the line with a standard telepermitted telephone and do not report a fault if the telephone performance is satisfactory.

This device is equipped with pulse dialling while the Telecom standard is DTMF tone dialling. There is no guarantee that Telecom lines will always continue to support pulse dialling.

Use of dialling, when this equipment is connected to the same line as other equipment, may give rise to bell noise and also cause a false answer condition. Should such problems occur, the user should **not** contact the Telecom Faults Service.

This equipment is set up to carry out test calls at pre-determined times. Such test calls interrupt any other calls that may be set up on the line at the same time. The timing set for such test calls should be discussed with the installer.

The timing set for test calls from this equipment may be subject to drift. If this proves to be inconvenient and your calls are interrupted, then the problem of timing should be discussed with the equipment installer. The matter should **not** be reported as a fault to Telecom Faults Service.

This equipment shall not be set up to make automatic calls to the Telecom 111 Emergency Service.

This equipment should not be used under any circumstances that may constitute a nuisance to other Telecom customers.

In the event of any problem with this device, the systems battery, AC mains supply, and telephone line should be disconnected. The user is to arrange with the supplier of the device to make the necessary repairs.

Should the matter be reported to Telecom as a wiring fault and the fault proven to be due to this product, a call-out charge is incurred.

Table of Contents

18.0	Testing.....	13
19.0	Event Memory Recall.....	13
20.0	Day Alarm	13
21.0	Codepad ID and Buzzer Tone	14
22.0	Partitioning	14
22.1	Master Partitioned Codepad Indicators.....	14
22.1.1	Zone Indicators	14
22.1.2	Area On/Off Indicators.....	14
22.1.3	Area Display Indicators.....	14
22.1.4	Status Indicators	14
22.2	Operation of Codepads in Partitioning	14
22.3	Arm/Disarm all Areas at the Same Time....	15
23.0	Remote Arming By Telephone	15
24.0	Operating the System by a Touch-Tone Telephone	15
25.0	Domestic Dialling	16
25.1	Acknowledging Domestic Calls.....	16
25.2	Programming Domestic Telephone Numbers	16
25.3	Disable Domestic Dialling	16
26.0	Domestic Voice Message Reporting.....	17
26.1	Acknowledging Domestic Voice Message Reporting	17
27.0	Basic Pager Reporting	17
27.1	Basic Pager Display Information.....	17
28.0	PET Pager Reporting.....	19
29.0	Glossary of Terms.....	20
30.0	Installation Notes	22
Figures		
Figure 1:	CP5 Eight Zone LED Codepad.....	5
Figure 2:	Sixteen Zone LED Codepad	5
Figure 3:	CP5 Eight Zone LCD Codepad	6
Figure 4:	Sixteen Zone LCD Codepad	6
Figure 5:	CP5 LED Codepad Showing Audible Alarm Buttons	10
Figure 6:	Sixteen Zone LED Codepad Showing Audible Alarm Buttons	10
Figure 7:	Master Partitioned Codepad.....	14
Figure 8:	Basic Pager Display	18

Tables

Table 1:	Specifications	5
Table 2:	Zone Indicator	6
Table 3:	AWAY Indicator	6
Table 4:	STAY Indicator	6
Table 5:	MAINS Indicator	7
Table 6:	FAULT Indicator	7
Table 7:	Audible Indicators.....	7
Table 8:	Arming Methods	7
Table 9:	How to Arm the System in AWAY Mode	8
Table 10:	How to Arm the System in STAY Mode 1	8
Table 11:	Fault Indicators.....	11
Table 12:	Output Devices On/Off	12
Table 13:	Codepad ID and Buzzer Tone Change	14
Table 14:	Domestic Dialling Telephone Digits	16
Table 15:	Zone Status Display Descriptions.....	17
Table 16:	System Status	17
Table 17:	PET Pager Messages	19
Table 18:	Example of a Single Transmission	19
Table 19:	Glossary of Terms	20

1.0 Introduction

Congratulations on selecting the Solution-16 Control Panel to protect you and your property. Take time to read through this manual and familiarise yourself with the operating features of this system. In all aspects of planning, engineering, styling, operation, convenience, and adaptability, we have sought to anticipate your every possible requirement.

Programming simplicity and speed were some of the major considerations and we believe that our objectives in this area were more than satisfied.

This manual explains all aspects of operating the control panel. All system parameters and options are detailed; however, suitability is left up to the individual. Every system can be tailored to meet all requirements quickly and easily.

2.0 Specifications

Table 1: Specifications

Temperature Range	0°C to +45°C (+32°F to +113°F)
Humidity	10% to 95%
Power Source	TF008 Plug Pack – 240 V/18 V AC @ 1.3 A
Stand-By Current	65 mA
Current Draw In Alarm Condition	115 mA
Current Draw In Alarm Condition With Codepad	105 mA
Back-Up Battery	7 Ah/12 V DC rechargeable sealed lead acid battery
Dimensions (case, packed in carton)	306 mm x 262 mm x 84 mm (12.05 in. x 10.31 in. x 3.31 in.)
Weight	2.5 kg (5.51 lbs.)
Supplier Code	N771
New Zealand Telepermit	PTC 211/95/263
Malaysia Approval Number	Pending



The Austel permit issued for this product is subject to the following conditions:
The Solution-16 Control Panel (CC880/LP880, SC8016) may only be powered by a Bosch Security Systems TF008 plug pack (Approval Number Q92128).



Test the sirens, strobe, and zones at weekly intervals. See *Section 18.0 Testing* for further information.

3.0 Codepad Indicators

Figure 1: CP5 Eight Zone LED Codepad

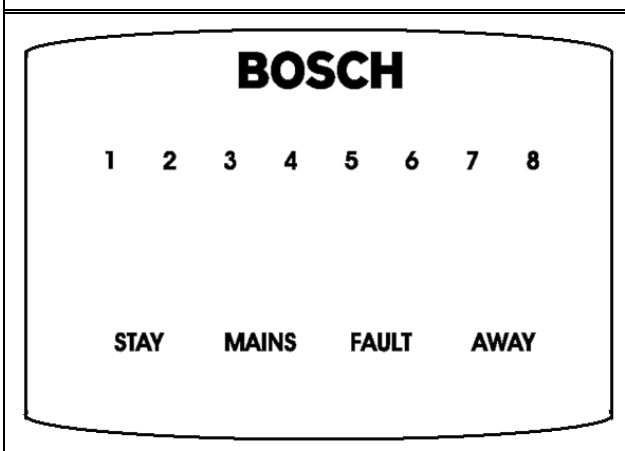

Figure 2: Sixteen Zone LED Codepad

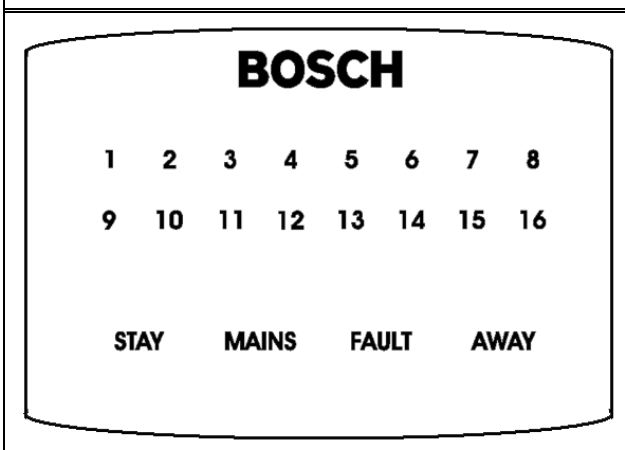

Figure 3: CP5 Eight Zone LCD Codepad

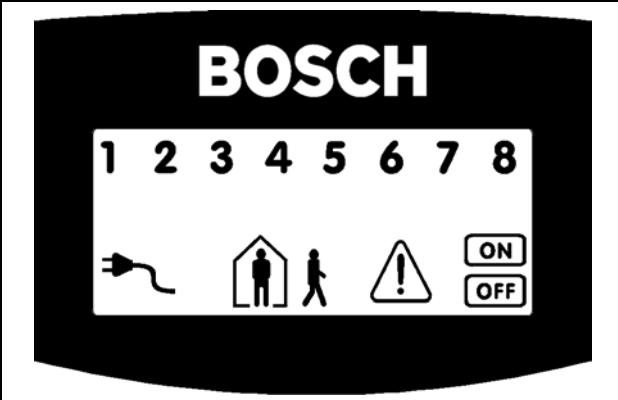
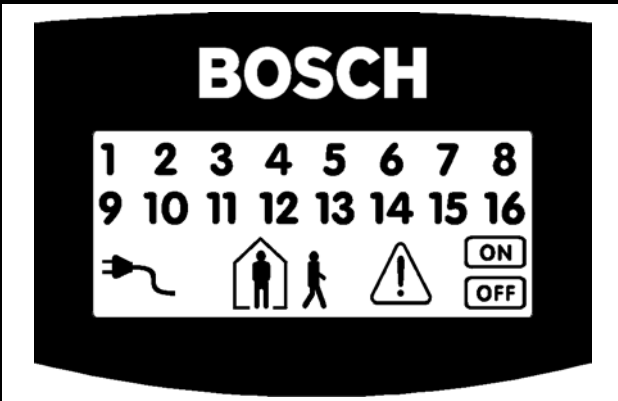

Figure 4: Sixteen Zone LCD Codepad



The codepad is the communications interface between you and your alarm system. Use the codepad to issue commands. The codepad offers both visual and audible indications that guide you through the general operation.

The codepad incorporates numerous indicators. There are zone indicators that show the condition of each zone and four other indicators for general status. The following pages outline a list of situations and the relevant indicators that are seen.

3.1 Zone Indicators

1 2 3 The zone indicators (1 to 8) display the status of the zones. *Table 2* lists the various circumstances under which the indicators display (such as, Zone Sealed/Zone Unsealed).

Table 2: Zone Indicator

Zone Indicator	Definition
On	Zone is unsealed
Off	Zone is sealed
Flashing Fast (0.25 sec. on/ 0.25 sec. off)	Zone is in alarm condition
Flashing Slow (1 sec. on/1 sec. off)	Zone is manually isolated or selected to be isolated

3.2 AWAY Indicator



The AWAY indicator shows the system is armed in AWAY Mode. The AWAY indicator also flashes in unison with the STAY indicator when programming various options throughout the *Operator's Manual*.

See *Section 4.2 Arming in AWAY Mode* for information on the different methods of arming the system in AWAY Mode.

Table 3: AWAY Indicator

AWAY Indicator	Definition
On	System is armed in AWAY Mode.
Off	System is not armed in AWAY Mode.

3.3 STAY Indicator



The STAY indicator displays that the system is armed in STAY Mode 1 or STAY Mode 2. The STAY indicator also flashes in unison with the AWAY indicator when programming various options throughout the *Operator's Manual*. See *Section 4.3 Arming in STAY Mode 1* for different methods of arming in STAY Mode 1. See *Section 4.4 Arming in STAY Mode 2* to arm in STAY Mode 2.

Table 4: STAY Indicator

STAY Indicator	Definition
On	System is armed in STAY Mode 1 or STAY Mode 2.
Off	System is not armed in STAY Mode 1 or STAY Mode 2.
Flashing twice a second	Zone isolating mode or setting STAY Mode 2 zones.
Flashing once every 3 sec.	Day alarm status – day alarm turned on.

3.4 System Disarmed



This indicator displays with the **OFF** indicator when the system is disarmed.

3.5 MAINS Indicator



The MAINS indicator displays that the systems AC mains supply is normal or failed.

Table 5: MAINS Indicator

MAINS Indicator	Definition
On	AC mains power normal.
Flashing	AC mains supply failed.

3.6 Off Indicator/Zone Sealed



The **OFF** indicator displays when the system is in the disarmed state and flashes when a zone becomes unsealed during the disarmed state. The indicator stops flashing when all zones are sealed.

3.7 On Indicator/Zone In Alarm



The **ON** indicator displays when the system is armed in AWAY Mode and flashed when an alarm occurs. The indicator resets once a valid user code is entered.

3.8 FAULT Indicator



The FAULT indicator displays when the system detects a system fault. See *Section 14.0 Fault Analysis Mode* for additional information on system faults. Every time a new system fault is detected (such as, FAULT indicator flashing), the codepad beeps once every minute. Pressing the [#] button once cancels the once a minute beep and acknowledges the fault (such as, FAULT indicator on steady).

Table 6: FAULT Indicator

FAULT Indicator	Definition
On	There is a system fault that must be rectified.
Off	The system is normal, there are no faults.
Flashing	There is a system fault that must be acknowledged.

3.9 Audible Indications

Table 7 defines the audible indicators emitted by the codepad buzzer.

Table 7: Audible Indicators

Audible Indicator	Definition
Once short beep	A button was pressed on the codepad, or end of exit time when armed in STAY Mode 1 or STAY Mode 2.
Two short beeps	The system accepted your code.
Three short beeps	The requested function was executed.
One long beep	Indicates the end of exit time when armed in AWAY Mode, or the requested operation was denied or aborted.
One beep every second	Walk Test Mode is currently active or warning before automatic arming takes place.
One short beep every minute	There is a system fault waiting to be acknowledged.

4.0 Arming the System

There are several ways to arm the system, depending on whether you are:

- leaving the premises and require all active zones to be in a ready state for an intruder, or
- remaining in the premises and only require part of the system to be in a ready state for an intruder.

If a zone is not sealed at the end of exit time, the zone is automatically isolated and is constantly displayed on the remote codepad. The zone becomes an active part of the system when the zone reseals. (For example, if a window is left open after exit time expires, the window is not an active part of the system until the window is closed. Opening the window after exit time expires causes an alarm condition.)

Table 8 defines the different methods for arming the system.

Table 8: Arming Methods

AWAY Mode	Arms the entire system. See <i>Section 4.2 Arming in AWAY Mode</i> .
STAY Mode 1	Arms all zones except those programmed to be automatically isolated by the installer. See <i>Section 4.3 Arming in STAY Mode 1</i> .
STAY Mode 2	Arms all zones except those programmed to be automatically isolated by the master code holder. See <i>Section 4.4 Arming in STAY Mode 2</i> .

4.1 Forced Arming

Forced arming arms the system when a zone is not sealed. If the system does not arm and a long beep is heard, forced arming is not permitted. In this case, you must ensure that all zones are sealed or manually isolated before you can arm the system.

4.2 Arming in AWAY Mode

When you leave your premises and require all zones to be in a ready state to detect intrusion, you arm the system in AWAY Mode.

There are two different methods for arming the system in AWAY Mode. Method one is standard and always operates. Method two is optional and can be disabled by your installer if you do not want to use single button arming.

Table 9: How to Arm the System in AWAY Mode

Method One	Enter your user code followed by the [#] button (for example, [2 5 8 0 #]). Two beeps are heard and the AWAY indicator displays. Exit time starts counting.
Method Two	Hold down the [#] button until two beeps are heard. The AWAY indicator displays and exit time starts counting.

4.3 Arming in STAY Mode 1

STAY Mode 1 is only used when the perimeter and unused areas of the premises need to be armed to detect an intruder entering the premises. At the same time, this mode allows you to move freely within an area that is automatically isolated.

Only your security company can program zones automatically isolated in STAY Mode 1.

There are two different methods for arming the system in STAY Mode 1. Method one is standard and always operates. Method two is optional and can be disabled by your installer if you do not want to use single button arming.

Entry Guard Timer For STAY Mode 1

When arming the system in STAY Mode 1, an optional entry timer called Entry Guard Timer For STAY Mode 1 is used. Use this entry timer to delay the sirens if a zone is not automatically isolated and triggered an alarm condition. Entry Guard Timer For STAY Mode 1 is the delay time used for all zones except 24-hr. zones when the system is armed in STAY Mode 1 or STAY Mode 2.

If the Entry Guard Timer For STAY Mode 1 is programmed and a zone not automatically isolated is triggered, the codepad beeps twice a second until the entry timer expires or the system is disarmed. If the alarm condition is not reset by entering your user code followed by the [#] button (such as, [2 5 8 0 #]) before the entry timer expires, the sirens activate into alarm. Only your installer can program this feature.

Table 10: How to Arm the System in STAY Mode 1

Method One	Enter your user code followed by the [*] button (for example, [2 5 8 0 *]). Two beeps are heard and the STAY indicator displays. Exit time starts counting. Any zones programmed to be automatically isolated in STAY Mode 1 flash until exit time expires. At the end of exit time, all zones selected to be automatically isolated turn off and the codepad gives one short beep.
Method Two	Hold down the [*] button until two beeps are heard. The STAY indicator displays and exit time starts counting. Any zones programmed to be automatically isolated in STAY Mode 1 flash until exit time expires. At the end of exit time, the zone indicators turn off and the codepad gives one short beep.

4.4 Arming in STAY Mode 2

STAY Mode 2 is only used when the perimeter and unused areas of the premises need to be armed to detect an intruder from entering the premises. At the same time, this mode allows you to move freely within an area that is automatically isolated. Any Master Code user can program zones to be automatically isolated in STAY Mode 2.

Entry Guard Timer For STAY Mode 2

When arming the system in STAY Mode 2, an optional entry timer called Entry Guard Timer for STAY Mode 2 can be used. Use this entry timer to delay the sirens if a zone is not automatically isolated and triggered into alarm condition. Entry Guard Timer for STAY Mode 2 is the delay time used for all zones except 24-hr. zones when the system is armed in STAY Mode 1 or STAY Mode 2.

If the Entry Guard Timer for STAY Mode 2 is programmed and a zone, not automatically isolated, triggers, the codepad beeps twice a second until the entry timer expires or the system disarms. If the alarm condition is not reset by entering your user code followed by the [#] button (for example, [2 5 8 0 #]) before the entry timer expires, the sirens activate into alarm. Only your installer can program this option.

How to Arm the System in STAY Mode 2

Hold down the [0] button until two beeps are heard. The STAY indicator displays and exit time starts counting.

Any zones programmed to be automatically isolated in STAY Mode 2 flash until exit time expires. At the end of exit time, all zones selected to be automatically isolated turn off and the codepad gives one short beep.

4.5 Programming STAY Mode 2 Zones

Programming zones to be automatically isolated in STAY Mode 2 are only carried out if you have a master code.

How to Program STAY Mode 2 Zones

1. Enter your four character master code, followed by [8] and the [#] button (for example, [2 5 8 0 8 #]). Three beeps are heard and the STAY indicator flashes.
2. Enter the zone number to be automatically isolated, followed by the [*] button (for example, [1 *] = Zone 1, [2 *] = Zone 2). The selected zone flashes. If you make a mistake, enter the same zone number followed by the [#] button to clear the incorrect zone. To select additional zones to be automatically isolated in STAY Mode 2, repeat Step 2 as many times as required.
3. To exit this mode, press the [#] button when you have selected all zones to be automatically isolated in STAY Mode 2. Two beeps are heard and the STAY and AWAY indicators turn off.

5.0 Disarming the System

When you enter the premises after the system is armed in AWAY Mode, or if you armed the system in STAY Mode 1 or STAY Mode 2, you must disarm the system before entry time expires to disable detection devices that activate an alarm.

If there was an alarm condition prior to disarming the system, a flashing zone indicator displays, indicating a previous alarm on that zone.

How to Disarm the System

Enter your user code followed by the [#] button (for example, [2 5 8 0 #]). Two beeps are heard.

6.0 Adding User Codes

Only the master code holder can add or change other system user codes, including two auxiliary codes and the master code. The master code is factory default is User 1; however, multiple user codes can be assigned to be a master code. Up to 32 user codes can be programmed to operate the system. User code 33 and user code 34 are auxiliary codes only.

How to Add a User Code

1. Enter your four character master code, followed by [1] and the [#] button (for example, [2 5 8 0 1 #]). Three beeps are heard and the STAY and AWAY indicators flash.
2. Enter the user code number (1 to 34), followed by the [#] button (for example, [2 #] = User 2, [3 3 #] = Auxiliary Code 1). Two beeps are heard and the selected user number displays on the codepad indicators.
3. Enter the digits (up to seven digits) required for the new code followed by the [#] button (for example, for user code 5768, enter [5 7 6 8 #]). Two beeps are heard and the STAY and AWAY indicators turn off. To add or change other user codes, repeat this procedure as many times as required.

7.0 Deleting User Codes

Only the master code holder can delete other system user codes and auxiliary code 1 and 2.

How to Delete a User Code

1. Enter your four character master code, followed by [1] and the [#] button (for example, [2 5 8 0 1 #]). Three beeps are heard and the STAY and AWAY indicators flash.
2. Enter the user code number (1 to 34), followed by the [#] button (for example, [2 #] = User 2, [3 3 #] = Auxiliary Code 1). Two beeps are heard and the selected user number displays on the codepad indicators.
3. Press the [*] button to delete the selected user code. Two beeps are heard and the STAY and AWAY indicators turn off. To delete other user codes, repeat this procedure as many times as required.

8.0 Codepad Duress Alarm

A codepad duress alarm is used as a silent hold-up alarm. This only occurs when the number “9” is added to the end of any valid user code being used to disarm the system (for example, [2 5 8 0 9 #]). A duress alarm is only useful if your system is reporting back to a monitoring station or pocket pager, because domestic reporting (such as a mobile phone) cannot decipher which type of alarm occurred.

Figure 5: CP5 LED Codepad Showing Audible Alarm Buttons

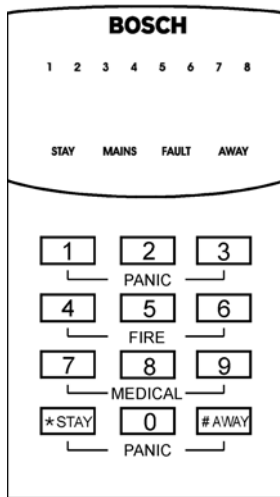
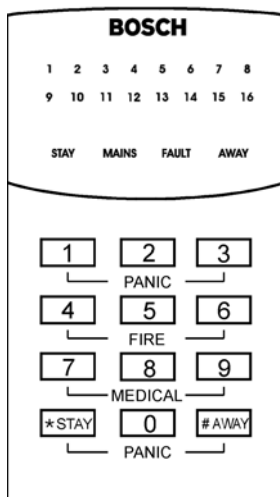

Figure 6: Sixteen Zone LED Codepad Showing Audible Alarm Buttons



9.0 Codepad Panic Alarm

An audible alarm activates when both the [1] and [3] buttons and both the [*] and [#] buttons are pressed simultaneously. Contact your installer to disable the ability to activate the codepad panic alarm or to silence the codepad panic alarm.



Software versions 1.10 through 1.36 sound a panic alarm when you press both the [4] and [6] buttons or the [7] and [9] buttons simultaneously.

10.0 Codepad Fire Alarm

(Version 1.37 + only) A distinct fire sound is emitted by the horn speaker when both the [4] and [6] buttons on the codepad are pressed simultaneously. Contact your installer if you want to disable the ability to activate the codepad fire alarm or if you want to silence the codepad fire alarm.

11.0 Codepad Medical Alarm

(Version 1.37 + only) An audible alarm activates when both the [7] and [9] buttons are pressed simultaneously. Contact your installer to disable the ability to activate the codepad medical alarm or to silence the codepad medical alarm.

12.0 Codepad Tamper Alarm (Access Denied)

Codepad tamper restricts the number of times an invalid user code can try to operate the system. When the number of incorrect code attempts equals the number programmed by your installer, the system activates an alarm condition. If reporting back to a security monitoring station, the system sends an Access Denied Report.

To shut down and lock out a codepad for a period of time (0 sec. to 150 sec.), ask your installer to program this feature.

13.0 Isolating Zones

Isolating zones allow you to manually disable one or more zones before arming the system. Once a zone is isolated, access is allowed into that zone during the armed state without activating an alarm.

For example, you need to isolate a zone before arming the system such as when a PIR detector causes a false alarm or you must leave a pet inside a particular zone while away.

Isolating zones is performed by one of two methods. Method two is optional and only allows those user codes programmed by your installer to isolate zones.

13.1 Standard Isolating

Standard isolating allows all operators to isolate zones without knowing a valid user code.

How to Isolate a Zone

1. Press the [*] button twice to enter the isolating mode.
Three beeps are heard and the STAY indicator flashes.
2. Enter the zone number (1 to 16), followed by the [*] button (for example, [1 *] = Zone 1, [1 6 *] = Zone 16).
Each zone to be isolated has a corresponding zone indicator that flashes. If you selected an incorrect zone to be isolated, enter the incorrect zone number again followed by the [*] button. Repeat Step 2 if more than one zone is to be isolated until all zones to be isolated are selected.
3. Press the [#] button after all selected zones are isolated.
Two beeps are heard and the system returns to the disarmed state.

13.2 Code to Isolate

Only those user codes with the Code to Isolate priority level can isolate zones. If any user code has this priority level, the method of standard isolating does not function. Your security company must program the priority level for each code.

How to Isolate a Zone

1. Press the [*] button followed by your user code and the [*] button again to enter the isolating mode (for example, [* 2 5 8 0 *]). Three beeps are heard and the STAY indicator flashes.
2. Enter the zone number (1 to 16), followed by the [*] button (for example, [1 *] = Zone 1, [1 6 *] = Zone 16).
Each zone to be isolated has a corresponding zone indicator that flashes. If you selected an incorrect zone to be isolated, enter the incorrect zone number again followed by the [*] button. Repeat Step 2 if more than one zone is to be isolated until all zones to be isolated are selected.
3. Press the [#] button after all selected zones are isolated.
Two beeps are heard and the system returns to the disarmed state.

14.0 Fault Analysis Mode

If a fault occurs, the FAULT or MAINS indicators flash and the codepad beeps once every minute.

If the AC mains supply failed, the MAINS indicator flashes until the AC mains supply is restored.

Pressing the [#] button once acknowledges the fault and stops the codepad from beeping once every minute.

How to Determine the Type of System Fault

To determine which system fault occurred, enter fault analysis mode.

1. Hold down button [5] until two beeps are heard. The FAULT indicator remains steady and the STAY and AWAY indicators flash in unison. Any zone indicators display the type of fault occurred. See 3.8 for the list of system faults that can occur.
2. To exit fault analysis mode and return to the disarmed state, press the [#] button. The FAULT indicator remains displayed and the codepad stops its once a minute beep.

Table 11: Fault Indicators

Zone Indicator	Fault Description
1	Battery Fail
2	Date and Time
3	Sensor Watch
4	Horn Speaker Fail
5	Telephone Line Fail
6	E2 Fault
7	Zone 16 in Alarm (partitioned systems only)
8	Communication Fail

14.1 Fault Descriptions

Battery Fail

A low battery fault registers when the system detects a low capacity back-up battery. The system automatically performs a battery test every 4 hrs. and also every time the system is armed.

Date and Time

The date and time fault registers every time the system is powered down. This type of fault does not cause the FAULT indicator to display on the codepad unless your installer programmed the automatic arming time. See *Section 15.0 Date and Time* to program the date and time.

Sensor Watch

A sensor watch fault registers because one or more detection devices failed to detect any movement during the disarmed state for the time period programmed by your installer. The fault clears once the zone in question detected movement and resets.

While in fault analysis mode, hold down button [5] until two beeps are heard and the zone that reported the sensor watch fault displays.

Horn Speaker Fail

A horn speaker failure fault registers when the system detects that the horn speaker is disconnected. This fault clears once the horn speaker is reconnected. Your installer needs to program the system for this feature to operate.

Telephone Line Fail

A telephone line failure fault registers when the system detects the telephone line is disconnected from the control panel. Your installer needs to program the system for this feature to operate.

E2 Fault

An E2 failure fault registers when the system detects an internal checksum error. Contact your installer as soon as this fault displays.

Zone 16 in Alarm (Partitioned Systems Only)

A Zone 16 in alarm fault registers when Zone 16 registers an alarm condition. The AUX indicator displays if a Master Partitioned codepad is used and the system is partitioned. Contact your installer regarding this fault.

Communication Fail

A communication failure fault registers when the control panel fails to communicate with the receiving party (such as a monitoring company, mobile phone, or pocket pager). The communication fault clears once the control panel successfully reports to the receiving party.



This fault condition registers when a communication by Safecom equipment fails (Version 2.00+).

To determine if the system failed to communicate by the telephone line or the communication by Safecom, press and hold button [8]. Zone 1 displays if the system failed to communicate by the telephone line and Zone 2 displays if the system failed to communicate by Safecom.

2. Enter the day, month, year, hour, and minute (DD, MM, YY, HH, MM format) (for example, DD = day of the month, MM = month of the year, YY = current year, HH = hour of the day, MM = minute of the day).
To program the hour of the day, use the 24:00 hour format.
3. Press the [#] button to exit and return to the disarmed state.
Two beeps are heard and the STAY and AWAY indicators turn off. If a long beep is heard, an error occurred when entering the date and time.

16.0 Turning Output Devices On/Off

This feature is only applicable if your security company has programmed an output that can operate external devices (such as, toggle on/off by the codepad). The output programmed by your security company can control a pool pump or outside lighting. Up to five different outputs can be programmed.

How to Turn an Output On or Off

1. Enter your four character master code, followed by [5] and the [#] button (for example, [2 5 8 0 5 #]).
Three beeps are heard and the STAY and AWAY indicators flash.
2. Enter the output number (1 to 5).
3. Press the [#] button to turn the output on or press the [*] button to turn the output off.
Three beeps are heard if the output is turned on and two beeps are heard if the output is turned off.
Repeat Step 2 and Step 3 if more than one output device is required to be turned on or off.
4. Press the [#] button to exit this function.
Two beeps are heard and the STAY and AWAY indicators turn off.

Using *Table 12*, have the security company detail the devices that can be turned on and off by the codepad. Output device 5 can be programmed to automatically turn on at the same time every day and can be overridden by the codepad.

15.0 Date and Time

Programming the date and time is only required when you need functions such as automatic test reports, automatic arming, and history events to operate correctly.

How to Program the Date and Time

1. Enter your four character master code, followed by [6] and the [#] button (for example, [2 5 8 0 6 #]).
Three beeps are heard and the STAY and AWAY indicators flashes.

Table 12: Output Devices On/Off

Output Device	Description
1	_____
2	_____
3	_____
4	_____
5 (Auto)	_____ Time _____ am/pm

17.0 Reset Latching Outputs

This feature is only applicable if your installer programmed an output to latch (remain on) until you acknowledge the event that occurred.

How to Reset Latching Outputs

Press and hold button [7] until two beeps are heard. The output resets.

18.0 Testing

Use the testing functions to verify your system is operating correctly.

Horn Speaker Test

Press and hold button [1] until two beeps are heard. The horn speaker sounds for 2 seconds.

Bell Test

Press and hold button [2] until two beeps are heard. The bell output operates for 2 seconds.

Strobe Test

1. Press and hold button [3] until three beeps are heard. The strobe flashes.
2. Press and hold button [3] until two beeps are heard.
The strobe stops flashing.

Walk Test Mode

Use the Walk Test Mode to test detection devices to ensure they are operating correctly. Every time you test a zone, the codepad sounds one long beep and the horn speaker sounds one short beep to indicate the zone is activated when testing.

1. Enter your four character master code, followed by [4] and the [#] button (for example, [2 5 8 0 4 #]).
Three beeps are heard and the STAY and AWAY indicators flash. The codepad beeps once every second while the system is in Walk Test Mode.
2. Activate all zones that require the test.
3. When you finish testing all required zones, press the [#] button to exit this mode. Two beeps are heard and the STAY and AWAY indicators turn off. The system returns to the disarmed state.

19.0 Event Memory Recall

Use this function to replay back the last 40 events that occurred to the system. The event memory history replays all alarms and arming/disarming of the system in AWAY Mode, STAY Mode 1, and STAY Mode 2. However, the system cannot differentiate between arming the system in STAY Mode 1 or STAY Mode 2.

How to Enter Event Memory

Enter your four digit master code, followed by [3] and the [#] button (for example, [2 5 8 0 3 #]). Three beeps are heard. The last 40 events display one at a time by the codepad indicators starting with the most recent event. A beep is heard as each event displays.

20.0 Day Alarm

Day alarm allows a combination of zones to be monitored during the disarmed state by beeping the codepad buzzer. Only your installer can program zones 1 to 4 to operate for day alarm.

Example

A day alarm can be set-up at the front door of a shop with a pressure mat or electronic beam that customers activate as they enter and exit the shop. As the customers walk onto the pressure mat or break the electronic beam, the codepad buzzer beeps.

How To Turn Day Alarm On and Off (Software Version 1.10 Only)

Enter your four character master code followed by [7] and the [#] button (for example, [2 5 8 0 7 #]).

Three beeps are heard when you turn the day alarm on. Two beeps are heard when you turn the day alarm off.

How To Turn Day Alarm ON (Version 1.20+)

Press and hold button [4] until three beeps are heard.

Day alarm turns on. All zones programmed for day alarm operation cause the codepad buzzer to beep during the disarmed state when activated.

How To Turn Day Alarm Off (Version 1.20+)

Press and hold button [4] until two beeps are heard. Day alarm turns off.



If your security company programs an output to latch on when a day alarm zone faults (unseals), pressing the [#] key once resets the output.

21.0 Codepad ID and Buzzer Tone

If you press and hold down button [8], the tone of the codepad buzzer changes. There are 50 different tones to choose from between 1500 Hz and 5000 Hz. If multiple codepads are installed, each codepad can have a different tone.

If the system is partitioned into multiple areas, the codepad displays the area that it is assigned to before the tone of the buzzer starts to change.

Table 13: Codepad ID and Buzzer Tone Change

Zone Indicator	Area Assigned
None	Not Assigned
1	Area 1
2	Area 2
3	Area 3
4	Area 4
7	Master Partitioned Keypad

22.0 Partitioning

Your control panel can be partitioned or split into four individual areas. Each areas can be operated from one master partitioned codepad, or from separate area addressable codepads.

22.1 Master Partitioned Codepad Indicators

The indicators on a master partitioned codepad are configured into four groups (such as, Zone Indicators, Area On/Off Display, Area Display, and Status Indicators). Refer to *Figure 7*. The following is a description of what the indicators mean.

Figure 7: Master Partitioned Codepad

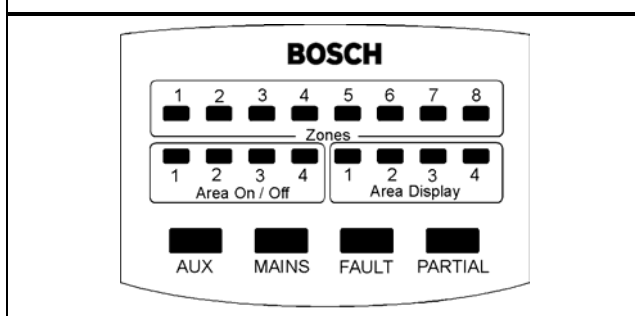

22.1.1 Zone Indicators

Zone indicators 1 to 8 show the status of each zone. These zones belong to the area that displays the AREA DISPLAY indicator. (For example, if an indicator is displayed, that zone is unsealed. If the indicator is not displayed, that zone is sealed.)

22.1.2 Area On/Off Indicators

The group of four AREA ON/OFF indicators display the status of each area. (For example, if an indicator is displayed, that area is armed. If the indicator is not displayed, that area is disarmed.)

22.1.3 Area Display Indicators

The group of four AREA DISPLAY indicators show which area the zones displayed belong to. All functions entered at the keypad only affect the area the keypad displays in the AREA DISPLAY. Press the [#] key to toggle between each area.

22.1.4 Status Indicators

A group of four indicators display the following:

AUX Indicator

Displays when the control panel is using the telephone line communicating with the receiving party.

MAINS Indicator

Displays the status of the AC mains power. (For example, if the indicator is illuminated, the AC mains power supply is normal. If the indicator is flashing, the AC mains power supply is disconnected or failed.)

FAULT Indicator

Displays the status of the fault register. (For example, if the FAULT indicator is flashing, the system detected a fault that was not acknowledged. If the FAULT indicator is illuminated, the fault is acknowledged. If the FAULT indicator is not illuminated, the system has no faults.)

PARTIAL Indicator

Only displays for an area armed in STAY Mode 1. (For example, if the PARTIAL indicator displays, an area is armed in STAY Mode 1. If the PARTIAL indicator does not display, no areas are armed in STAY Mode 1.)

22.2 Operation of Codepads in Partitioning

Area Addressable Codepad Operations

If you have a system that is partitioned with area addressable eight zone codepads, the operating procedure is exactly the same as described for a non-partitioned system except that all operations only relate to the area the codepad is assigned to.

Master Partitioned Codepad Operations

If you have a system that is partitioned with a master partitioned codepad installed, the operating procedure is exactly the same as described for a non-partitioned system, except that all operations only relate to the area displayed by the AREA DISPLAY indicator.

Example

If the AREA DISPLAY displays number 2, all operations performed only operate Area 2. To operate Area 1, you need to press the [#] key until the AREA DISPLAY displays number 1. Pressing the [#] button again toggles you back to the Area 2 display.

22.3 Arm/Disarm all Areas at the Same Time

If the system is partitioned into multiple areas, a user can arm or disarm all assigned areas at the same time. Your security company must program this feature before it works.

How to Arm/Disarm all Areas at the Same Time

Enter your code followed by [0] and the [#] key (for example [2 5 8 0 0 #]).



V2.03+: If you attempt to turn all areas on and one or more zones are unsealed (faulted) in any of the areas, the system does not allow you to turn all areas on if forced arming is disabled. You need to restore all unsealed (faulted) zones before the system allows you to turn all areas on at the same time.

23.0 Remote Arming By Telephone

Use this feature to arm your system from any remote location by telephone. For obvious security reasons, the system cannot be disarmed using this method. To make use of this feature, a touch-tone telephone is required. Your security company needs to program this feature to operate.

How to Remotely Arm Your System by the Telephone

1. Call the telephone number your control panel connects to.
2. With a DTMF command module, press the [#] key on a touch-tone telephone keypad to remotely arm the system.

If you hear modem tones when the control panel answers the incoming call, this means the system was programmed for remote programming functions by your installer. Simply wait for a pause between the tones before pressing the [*] button.

Two beeps are heard to indicate that the system is armed in AWAY Mode.

3. Hang up the telephone and the system remains armed.



If your installer programs answering machine bypass, call the control panel twice to make a connection with the system. For example, call the telephone number your control panel is connected to and let the call ring no more than four rings. Hang up the telephone. Wait a minimum of 8 sec. before you call the control panel back.

24.0 Operating the System by a Touch-Tone Telephone

If the system is installed with an optional DTMF command module, the system can be operated by a touch-tone telephone. Once a communication link is established between a touch-tone telephone and your alarm system, you can operate the system by the telephone as if you were operating the system from a codepad.

How to Establish a Communication Link

1. Dial the telephone number the system is connected to. When the system answers your call, you hear a short jingle.
2. Press the [0] key on your telephone. If the system registered the tone generated by pressing the [0] key, you hear a second jingle. You have established a link.

If your system is partitioned, press the key that corresponds to the area that you want to establish a connection to (for example, press [1] for Area 1, [2] for Area 2, [3] for Area 3, and [4] for Area 4).

3. You can now operate the system as if you were at the codepad.



Once you establish a link with a system that is partitioned, you cannot toggle between areas by pressing the [#] key (see *Section 22.1.3 Area Display Indicators*). You are required to establish separate connections for each area that you want to operate.

How to Terminate a Communication Link

Press the [#] key on the telephone twice to terminate the link. You hear tones of decreasing pitch to indicate termination of the link.

Alternatively, you can hang up the telephone and the system disconnects from the telephone network after 60 seconds.

25.0 Domestic Dialling

Use domestic dialling to call your mobile phone or a relative/friend in the event your control panel activated an alarm. Up to three different telephone numbers can be programmed for the control panel to call when an alarm occurs. Only your installer can program the system to report in the domestic format. However, the master code holder can change the telephone numbers at any time.

25.1 Acknowledging Domestic Calls

When an alarm condition occurs, the system calls the first telephone number programmed. When you answer an incoming call, you hear the system emitting a siren tone followed by a pause and repeat continually for 2 min. (for example, siren tone, pause, siren tone, and pause).

If you do not acknowledge the call from the control panel during a pause between siren tones, the control panel hangs up after 2 min. and calls the next telephone number.

Pressing the [*] button for 1 sec. to 3 sec. during the pause acknowledges the call and no further calls are made for that event. If the call was successfully acknowledged, a tone of decreasing pitch is heard.

Table 14: Domestic Dialling Telephone Digits

Digit Required	Number To Program
0	0
1	1
2	2
3	3
4	4
5	5
6	6
7	7
8	8
9	9
*	*1
#	*2
4 sec. pause	*3
Break	*4

25.2 Programming Domestic Telephone Numbers

If your system is set up for domestic dialling, this function allows any master code holder to program telephone numbers the control panel calls in an alarm.

How to Program Telephone Numbers

1. Enter your four character master code, followed by [2] and the [#] button (for example, [2 5 8 0 2 #]).
Three beeps are heard and the STAY and AWAY indicators flash.
If there are telephone numbers already programmed, they are displayed one digit at a time by the codepad indicators.
If there are no telephone numbers programmed, two more beeps are heard after entering this mode. These two beeps are normally heard after the last digit of the last telephone number is displayed.
2. Enter all digits for the first telephone number (for example, [9 6 7 2 1 7 1 7]).
As each digit is entered, the corresponding codepad indicators display.
3. If there is more than one telephone number to be programmed, press [*]. This inserts a break between the first telephone number and the second telephone number. If there is only one telephone number to be programmed, press the [#] button to exit this function.
4. Enter all the digits of the second telephone number (for example, [9 6 7 2 1 0 5 5]).
As each digit is entered, the corresponding codepad indicators display.
5. After the last digit of the second telephone number is programmed, press the [#] button to exit this function unless a third telephone number is required. If there is a third telephone number to be programmed, press the [*] button to insert a break between the second telephone number and the third telephone number.

25.3 Disable Domestic Dialling

To cancel domestic dialling (for example, you are moving and do not want the system to continue calling your mobile phone), enter the following sequence.

1. Enter your four character master code, followed by [2] and the [#] button (for example, [2 5 8 0 2 #]).
Two beeps are heard and the STAY and AWAY indicators flash.
2. Press the [*] button followed by the [#] button (for example, [* #]).
The STAY and AWAY indicators are disabled.

26.0 Domestic Voice Message Reporting

The system can be configured by your security company to report to your mobile phone when an alarm occurs and play back a pre-recorded message detailing instructions.

The pre-recorded message (up to a maximum of 16 sec. in length) can be changed as many times as necessary. You need to discuss the recording of your message with your security company. To change or program new telephone numbers, see *Section 25.2 Programming Domestic Telephone Numbers*.

26.1 Acknowledging Domestic Voice Message Reporting

When an alarm registers at the control panel, the control panel starts dialling the first telephone number. The recorded voice message starts playback as soon as the control panel dials the first telephone number and repeats itself continuously for 90 seconds.

When you answer the incoming call from the control panel, wait for the recorded message to end. A series of short tones follow the recorded message followed by a 20 sec. pause before the control panel hangs up and dials the next telephone number.

During the 20 sec. pause, press the [*] button on your touch-tone telephone. Alternatively, you can use an optional phone controller (tone generator) if you do not have a touch-tone telephone.



If an optional DTMF Command Module is installed by your security company, you can acknowledge the call during the message playback by pressing the [#] key. You no longer need to wait for the pre-recorded message to end.

27.0 Basic Pager Reporting

This feature is only applicable if your system is reporting to a pocket pager. Basic pager reporting requires some interpretation of the numbers that appear on the display. It is possible to differentiate between 1000 different systems when a number of control panels are reporting to the one pocket pager.

27.1 Basic Pager Display Information

Subscriber ID Number

This is the identification number of the control panel and can only be programmed by your installer.

Zone Status

The zone status display shows you the status of each zone (1 to 8). *Table 15* describes what each number means when displayed on the zone status display.

Table 15: Zone Status Display Descriptions

Number Displayed	Zone Description
0	Zone Normal Indicates the corresponding zone is in the sealed state.
1	Alarm Indicates the corresponding zone is unsealed and in alarm condition.
2	Zone Bypassed Indicates a system operator manually isolated the corresponding zone. See <i>Section 13.0 Isolating Zones</i> for information on how to manually isolate a zone(s) prior to arming the system.
3	Zone Trouble Indicates a zone was left unsealed after the end of exit time.

System Status

The system status information is divided into four digits.

Table 16: System Status

System Status Display	Description
First digit	Indicates whether the system is armed or disarmed: 8 = Disarmed 9 = Armed
Second digit	Indicates which codepad alarm was triggered by the operator: 0 = No Codepad Alarm 1 = Codepad Panic or Duress Alarm 2 = Codepad Fire Alarm 3 = Codepad Medical Alarm
Third digit	Indicates when the AC mains supply has failed: 0 = AC Supply is normal 1 = AC Supply has failed
Fourth digit	Indicates when a system fault has occurred at the control panel: 0 = System Normal – There are no faults. 1 = System Fault – There is a fault registered by the control panel.

Figure 8: Basic Pager Display

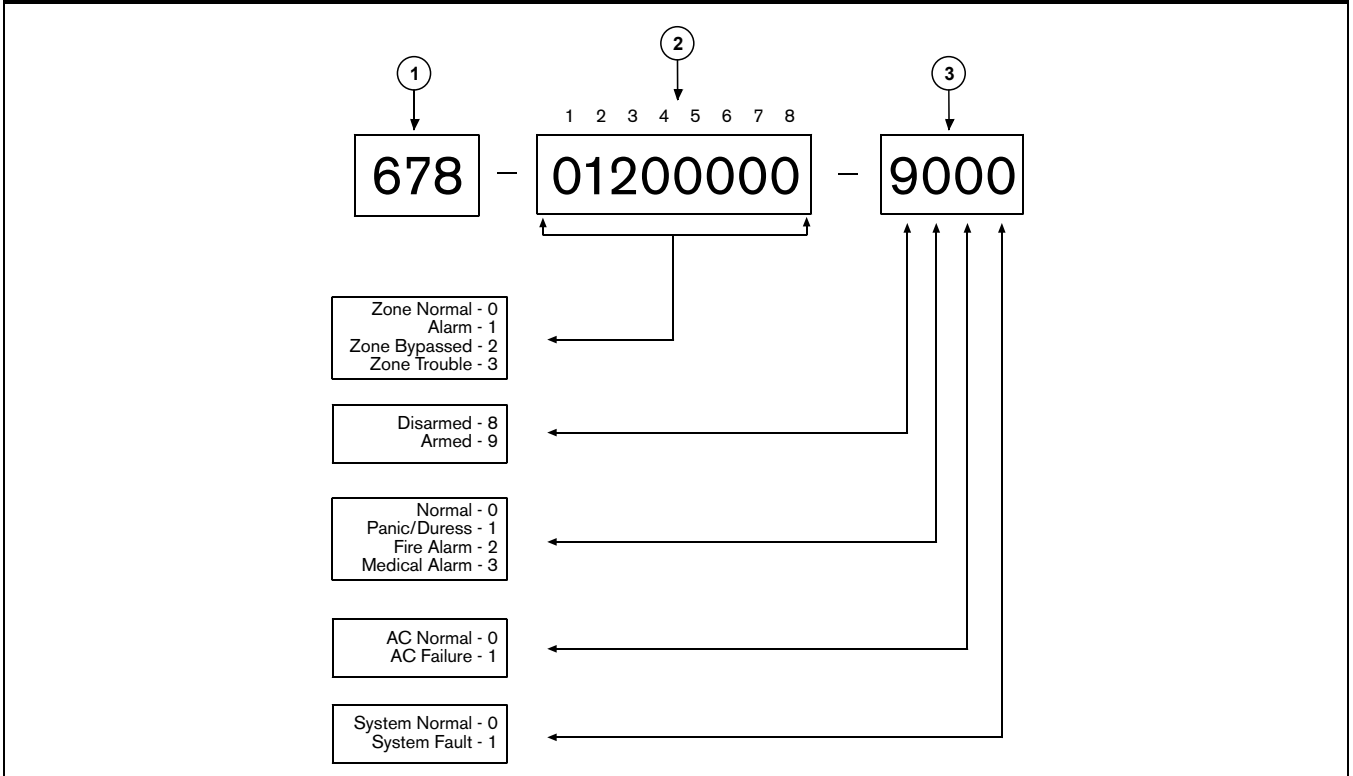

1 - Subscriber ID Number

2 - Zone Status

3 - System Status

Figure 8 shows the transmission came from the control panel with an ID number of 678 and that zone 2 is in alarm. The figure also displays that zone 3 was manually isolated and the system armed.

28.0 PET Pager Reporting

The system can be configured by your security company to report to a pocket pager when an alarm and/or any system event occurs. When using either of these two reporting formats, easy to understand text messages are received so that the appropriate action can be taken.

Table 17 lists all the events that can be reported in PET pager formats.

Table 17: PET Pager Messages

Event At Control Panel	PET Message
AC Fail	AC Fail
AC Restore	AC Restore
Area Has Been Armed	Close Area #, User #
Area Has Been Disarmed	Open Area #, User #
Burglary Zone Has Triggered	Alarm Zone #
Burglary Zone Has Restored	Restore Zone #
Burglary Zone Triggered, Area #	Alarm Zone #, Area #
Burglary Zone Restored, Area #	Restore Zone #, Area #
Access Denied – Codepad Tamper	Codepad Tamper
Data Programming Change	Data Change
System Is Armed	Close User #
System Is Disarmed	Open User #
Codepad Duress	Duress, Open User #
Low Battery	Low Battery
Low Battery Restore	Battery Restore
Codepad Panic Alarm	Panic
Codepad Fire Alarm (V1.37+)	Fire
Codepad Medical Alarm (V1.37+)	Medical
Test Report	Test
Zone Automatically Isolated When Armed	Bypass Zone #
Disarming When Zone Has Been Isolated	Bypass Restore Zone #
Zone Unsealed At End Of Exit Time	Trouble Zone #
Zone Has Restored After Exit Time	Trouble Restore #
24 Hour Zone Triggered	24 Hour Alarm #
24 Hour Zone Restored	24 Hour Restore #
24 Hour Fire Zone Triggered	Fire Zone #
24 Hour Fire Zone Restored	Fire Restore #

The # symbol represents the zone or area number in the transmission.

The following example shows how a single transmission is received on the PET pager. A similar message to the one below is seen when the control panel is armed by User 1.

Table 18: Example of a Single Transmission

1111	CLOSE USER	01
Subscriber ID Number	System Armed	User #1

The Subscriber ID number is a unique 4 digit number identifying which alarm system made the call. Only your security company can program the Subscriber ID number (Factory Default = 0000).

29.0 Glossary of Terms

Table 19: Glossary of Terms

Term	Description
24-Hour Zones	A monitored input programmed to trigger an alarm condition when violated when the system is armed or disarmed 24 hours a day.
Alarm Condition	Occurs when your alarm system is armed and one of the detection devices was violated. A 24-hr. zone (such as a smoke detector) can activate an alarm condition when your system is armed or disarmed.
Answering Machine Bypass	Answering machine bypass was incorporated. It is possible to make a connection with the system for remote arming operations when there is an answering machine or facsimile machine on the same telephone line.
Area Codepad	Used only when the system is partitioned into two separate areas. All operations at the area codepad do not affect the other area.
Armed	When the system is in a ready state to accept alarms.
Automatic Arming	This feature allows the system to automatically arm at the same time every day in AWAY Mode or STAY Mode 1.
Automatic Disarming	This feature allows the system to automatically disarm at the same time every day.
AWAY Mode	The mode used to arm your system when you leave your premises.
Codepad	The codepad allows you to arm/disarm the system and carry out other functions such as adding and deleting system user codes.
Day Alarm	This feature allows a combination of zones to be monitored while the system is disarmed.
Detectors	Devices connected to your alarm system used to detect intrusion and cause an alarm condition. Some forms of detection devices include, passive infrared (PIR), smoke detectors, photoelectric beams, reed switches, and vibration sensors.
Disarmed	Your system is in a state that does not accept alarms except on zones programmed for 24-hr. operation.
Dynamic Battery Testing	A feature used to monitor and test the condition of your back-up battery.
Entry Time/Entry Delay	The time allowed after entering your premises by a zone programmed for delayed operation so that you can disarm the system.
Exit Time	The time allowed after arming the system to exit the premises without causing an alarm.
External Equipment	Any device connected to your system such as detectors, codepads, and sirens.
Forced Arming	A situation where your alarm system is permitted to be armed when one or more zones are unsealed.
Handover Delay	Your system is armed and a zone programmed for delay was violated. The delay zone hand overs the remaining delay time to a zone programmed as handover. The handover zone does not activate an alarm until the remaining delay time expires. A handover zone acts as an instant zone if violated before the delay zone.
Hand Held Remote Control	Used to remotely operate your system by hand held transmitters.
Isolating	Manually disables (isolates) one or more zones before arming the system.
Master Code	A numerical code used for arming and disarming the system, as well as allowing access to functions such as adding and deleting user codes.
Master Partitioned Codepad	Codepad only used if your system is partitioned (CC488 only). The codepad allows you to view and operate both areas from the same codepad.
Monitoring Station	A secure location where a digital receiver monitors numerous alarm systems and deciphers their Alarm Transmission Reports. The operator can advise the appropriate authorities to take immediate action.
Panic Alarm	This type of alarm indicates to the monitoring station that there is an emergency situation at your premises.

Table 19: continued

Term	Description
Phone Controller	The phone controller can be used to turn your system on in AWAY Mode via the telephone by generating a tone.
Sealed	Refers to zone status. If a zone is sealed, the detection device is not violated and the zone indicator does not display on the codepad.
Sensor Watch	Sensor watch gives the control panel the ability to recognise that detection devices may have stopped working or that the view to a PIR detector is blocked (unable to detect any movement over the duration of the time programmed by your installer).
Silent Alarm	Your installer can program zones for silent operation. This means when the zone programmed for silent operation is violated during the armed period, your alarm system communicates with the monitoring station without sounding the sirens.
STAY Mode 1	A condition that automatically isolates zones when your system is armed in STAY Mode 1. Only your installer can program zones to be isolated automatically in STAY Mode 1.
STAY Mode 2	A condition that automatically isolates zone when your system is armed in STAY Mode 2. Only the master code holder can program zones to be isolated automatically in STAY Mode 2.
Telco Arm Sequence	Telco arming is a feature that automatically calls the telephone exchange and diverts your telephone number to another telephone when the system is armed in AWAY Mode. (In Australia, this feature is called "Call Forward".)
Telco Disarm Sequence	Telco disarming automatically calls the telephone exchange and does not forward your telephone number.
Unsealed	Refers to zone status. A zone is unsealed when a zone is violated. The corresponding zone indicator displays on the codepad.
User Code	A user code is the personal identification number that the operator uses to arm and disarm the system.
Zones	A monitored input used to trigger an alarm condition when violated.

30.0 Installation Notes

Installation Company

Technician's Name

Technician's Telephone Number

Installation Date

Warranty Expires

Panel Software Version

Service Notes

Zone Description

Describe each zone and mark which zones were programmed to be automatically isolated in STAY Mode 1 or were programmed for day alarm operation.

		Isolated In STAY Mode 1	Day Alarm Enabled
Zone 1	_____	<input type="checkbox"/>	<input type="checkbox"/>
Zone 2	_____	<input type="checkbox"/>	<input type="checkbox"/>
Zone 3	_____	<input type="checkbox"/>	<input type="checkbox"/>
Zone 4	_____	<input type="checkbox"/>	<input type="checkbox"/>
Zone 5	_____	<input type="checkbox"/>	<input type="checkbox"/>
Zone 6	_____	<input type="checkbox"/>	<input type="checkbox"/>
Zone 7	_____	<input type="checkbox"/>	<input type="checkbox"/>
Zone 8	_____	<input type="checkbox"/>	<input type="checkbox"/>
Zone 9	_____	<input type="checkbox"/>	<input type="checkbox"/>
Zone 10	_____	<input type="checkbox"/>	<input type="checkbox"/>
Zone 11	_____	<input type="checkbox"/>	<input type="checkbox"/>
Zone 12	_____	<input type="checkbox"/>	<input type="checkbox"/>
Zone 13	_____	<input type="checkbox"/>	<input type="checkbox"/>
Zone 14	_____	<input type="checkbox"/>	<input type="checkbox"/>
Zone 15	_____	<input type="checkbox"/>	<input type="checkbox"/>
Zone 16	_____	<input type="checkbox"/>	<input type="checkbox"/>

User Code Names

Default = 2580	User Code 1	_____	Master Code <input checked="" type="checkbox"/> Y	User Code 17	_____	<input type="checkbox"/>
	User Code 2	_____	<input type="checkbox"/>	User Code 18	_____	<input type="checkbox"/>
	User Code 3	_____	<input type="checkbox"/>	User Code 19	_____	<input type="checkbox"/>
	User Code 4	_____	<input type="checkbox"/>	User Code 20	_____	<input type="checkbox"/>
	User Code 5	_____	<input type="checkbox"/>	User Code 21	_____	<input type="checkbox"/>
	User Code 6	_____	<input type="checkbox"/>	User Code 22	_____	<input type="checkbox"/>
	User Code 7	_____	<input type="checkbox"/>	User Code 23	_____	<input type="checkbox"/>
	User Code 8	_____	<input type="checkbox"/>	User Code 24	_____	<input type="checkbox"/>
	User Code 9	_____	<input type="checkbox"/>	User Code 25	_____	<input type="checkbox"/>
	User Code 10	_____	<input type="checkbox"/>	User Code 26	_____	<input type="checkbox"/>
	User Code 11	_____	<input type="checkbox"/>	User Code 27	_____	<input type="checkbox"/>
	User Code 12	_____	<input type="checkbox"/>	User Code 28	_____	<input type="checkbox"/>
	User Code 13	_____	<input type="checkbox"/>	User Code 29	_____	<input type="checkbox"/>
	User Code 14	_____	<input type="checkbox"/>	User Code 30	_____	<input type="checkbox"/>
	User Code 15	_____	<input type="checkbox"/>	User Code 31	_____	<input type="checkbox"/>
	User Code 16	_____	<input type="checkbox"/>	User Code 32	_____	<input type="checkbox"/>
	Auxiliary #1 (User #33)	_____		Auxiliary #2 (User #34)	_____	

Entry/Exit Times

Entry Timer 1	_____	Exit Time	_____
Entry Timer 2	_____	Entry Guard Time	_____
Entry Timer 3	_____		
Entry Timer 4	_____		

Arming Options

Single Button Arming (AWAY/STAY)	<input type="checkbox"/> YES	<input type="checkbox"/> NO	Forced Arming	<input type="checkbox"/> YES	<input type="checkbox"/> NO
Single Button Disarming (STAY Mode)	<input type="checkbox"/> YES	<input type="checkbox"/> NO	Remote Arming By Telephone	<input type="checkbox"/> YES	<input type="checkbox"/> NO
Automatic Arm in AWAY Mode	<input type="checkbox"/> YES	<input type="checkbox"/> NO	Automatic Arming STAY Mode	<input type="checkbox"/> YES	<input type="checkbox"/> NO
Automatic Arming Warning Time	_____		Minutes		
Automatic Arming Time	_____		AM/PM		
Automatic Disarming Time	_____		AM/PM		

Output Descriptions

Output 1	_____	Output 8	_____
Output 2	_____	Output 9	_____
Output 3	_____	Output 10	_____
Output 4	_____	Output 11	_____
Output 5	_____	Output 12	_____
Output 6	_____	Output 13	_____
Output 7	_____	Output 14	_____

Isolating Method

Standard Isolating	<input type="checkbox"/> YES	<input type="checkbox"/> NO
Code To Isolate	<input type="checkbox"/> YES	<input type="checkbox"/> NO

Communication Options

Back To Base Reporting	<input type="checkbox"/> YES	<input type="checkbox"/> NO	Panel Account Number	_____
Domestic Reporting	<input type="checkbox"/> YES	<input type="checkbox"/> NO	Domestic Reporting – No Of Beeps	_____
Basic Pager Reporting	<input type="checkbox"/> YES	<input type="checkbox"/> NO	PET Pager/SMS Reporting	<input type="checkbox"/> YES <input type="checkbox"/> NO
Remote Arming Allowed	<input type="checkbox"/> YES	<input type="checkbox"/> NO	DTMF Command Module Fitted	<input type="checkbox"/> YES <input type="checkbox"/> NO

Other System Information

Siren Run Time Minutes

Sensor Watch Interval In Days

Can Your System Be Serviced By Another Technician YES NO If Yes, Installer's Code _____

Index

24-Hour Zones	19	Domestic Dialling	15
A		Acknowledging Domestic Calls.....	15
Adding User Codes.....	8	Disable.....	15
Alarm Condition.....	19	Programming Domestic Telephone	
Answering Machine Bypass	19	Numbers.....	15
Area Addressable Codepad.....	13	Duress Alarm.....	9
Area Codepad.....	19	E	
Area Display Indicator.....	13	E2 Fault.....	10
Area On/Off Indicator.....	13	Entry Delay/Entry Time.....	19
Armed.....	19	Entry Guard Timer.....	7
Arming		Event Memory Recall	12
AWAY Mode.....	6	Exit Time	19
STAY Mode 1	7	External Equipment.....	19
STAY Mode 2.....	7	F	
Telephone Arming	14	Fault Analysis	10
Audible Indications	6	Fault Description	
Automatic Arming.....	19	Battery Fail.....	10
Automatic Disarming.....	19	Communication Fail	11
AWAY Indicator	5	Date and Time.....	10
AWAY Mode.....	6, 19	E2 Fault	10
B		Horn Speaker Fail.....	10
Battery Fail	10	Sensor Watch.....	10
Battery Testing.....	19	Telephone Line Fail.....	10
Bell Test.....	12	Zone 16 in Alarm.....	11
C		FAULT Indicator	6, 13
Codepad	19	Fire Alarm.....	9
Buzzer Tone	13	Forced Arming.....	6, 19
Duress Alarm	9	H	
Fire Alarm	9	Hand Held Remote Control.....	19
Medical Alarm	9	Handover Delay.....	19
Panic Alarm.....	9	Horn Speaker Fail.....	10
Tamper Alarm.....	9	Horn Speaker Test.....	12
Codepad Indicators		I	
Audible Indications	6	Installation Notes	21
AWAY Indicator	5	Introduction.....	4
FAULT Indicator	6	Isolating.....	19
MAINS Indicator.....	5	Isolating Zones	9, 10
Off Indicator.....	5	Code to Isolate	10
On Indicator.....	5	Standard Isolating	9
STAY Indicator.....	5	M	
System Disarmed	5	MAINS Indicator.....	5, 13
Zone Indicators	5	Master Code	19
Communication Fail.....	11	Master Partitioned Codepad.....	19
D		Area Display Indicator	13
Date and Time	10, 11	Area On/Off Indicator	13
Day Alarm.....	12	FAULT Indicator	13
Deleting User Codes	8	MAINS Indicator	13
Detectors.....	19	Operating.....	13
Disarmed	19	Partial Indicator	13
Disarming.....	8		

Zone Indicators 13

Medical Alarm 9

Monitoring Station 19

O

Off Indicator 5

On Indicator 5

Output

 Reset Latching Outputs 12

 Turning On/Off 11

P

Pager Reporting 16

Panic Alarm 9, 19

Partial Indicator 13

Partitioning

 Area Addressable Codepad 13

 Area Display Indicator 13

 Area On/Off Indicator 13

 Codepad Operations 13

 Zone Indicators 13

Phone Controller 20

R

Remote Arming By Telephone 14

Remote Control 19

S

Sealed 20

Sensor Watch 10, 20

Silent Alarm 20

Specifications 4

STAY Indicator 5

STAY Mode 1 7, 20

 Entry Guard Timer 7

STAY Mode 2 7, 20

 Entry Guard Timer 7

 Programming Zones 8

Strobe Test 12

System Disarmed 5

T

Tamper Alarm 9

Telco Arm Sequence 20

Telco Disarm Sequence 20

Telephone Line Fail 10

Testing

 Bell Test 12

 Horn Speaker Test 12

 Strobe Test 12

 Walk Test 12

U

Unsealed 20

User Codes 20

 Adding 8

 Deleting 8

W

Walk Test 12

Z

Zone 16 in Alarm 11

Zone Indicators 5, 13

Zones 20

Notes:

Notes:

Notes:

Bosch Security Systems
25 Huntingwood Drive
Huntingwood NSW 2148
Australia
Phone: +612 9672 1777
Facsimile: +612 9672 1717

© 2003 Bosch Security Systems
920036O
4998152460B
Issue 1.62

BOSCH